

# OKA EasyUp / OKA EasyUp Twin

EasyUp – clever und flexibel / EasyUp Twin - intuitiv und smart  
EasyUp – clever and flexible / Easy Up Twin - intuitive and smart







Einfach effizient:  
teilmontierter Hublittisch,  
werkzeuglos montierbar

Simply efficient:  
adjustable-height desk,  
partly assembled

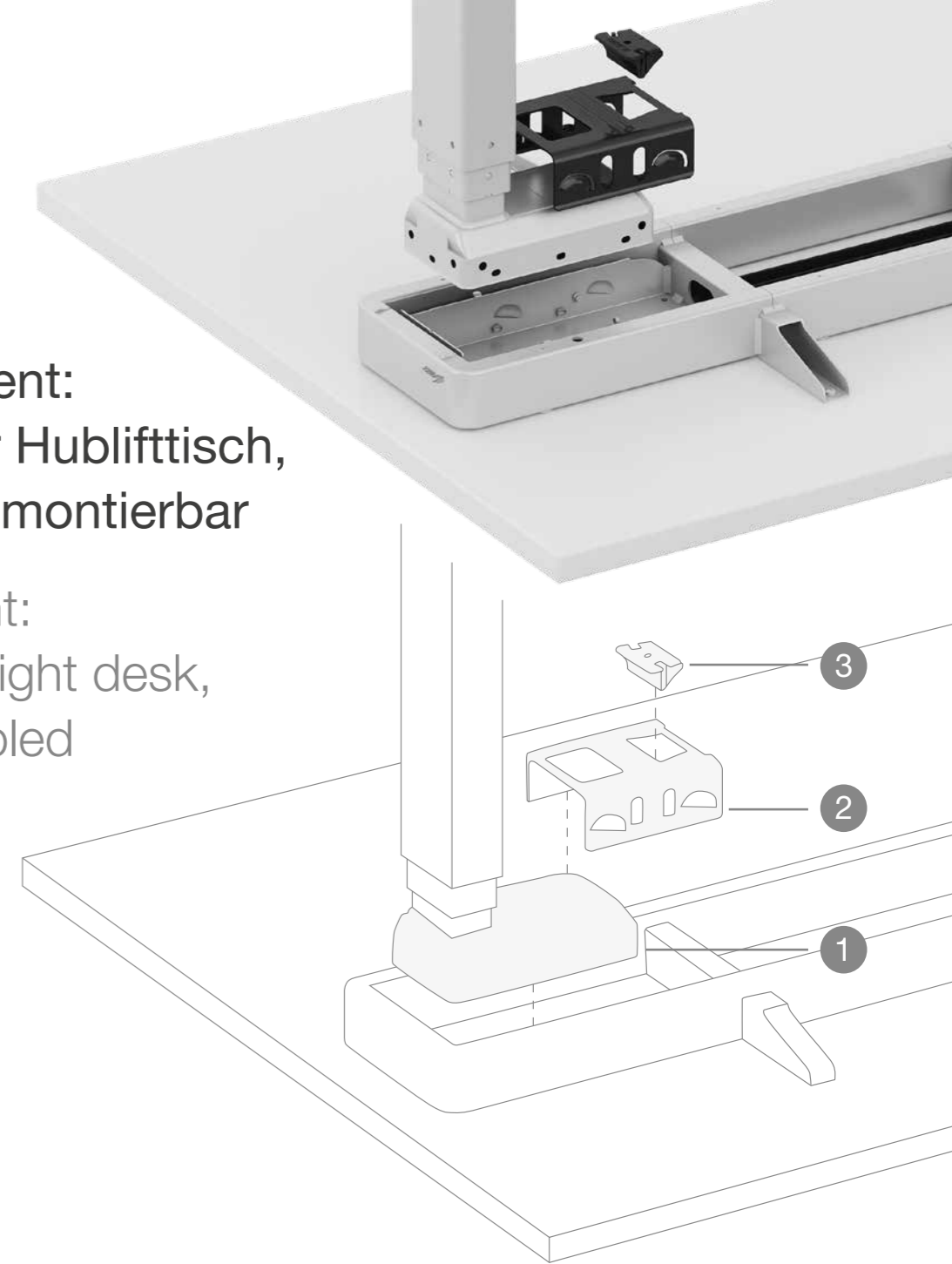

## OKA EasyUp

### OKA EasyUp

Flexibilität und Effizienz resultieren oft aus Konzepten, die in ihrer Überzeugungskraft vor allem klar und einfach erscheinen. Bei den elektrisch höhenverstellbaren Projektischen OKA EasyUp besticht zunächst die einleuchtende Lösung zum werkzeuglos klickbaren Aufbau. Sie ermöglicht eine teilmontierte Anlieferung, die Transportkapazitäten spart, und erlaubt jederzeit leichtes Vertragen bei schneller (erneuter) Einsatzfähigkeit sowie eine effiziente Lagerung. Optional liefern wir EasyUp aber auch komplett montiert. EasyUp ist als Rechteckstisch in den Abmessungen 160/180 cm x 80/90 cm erhältlich. Bei der teilmontierten Version erfolgt der Aufbau in drei einfachen Schritten nach dem Kick & Click™-Prinzip (siehe Grafik): 1. Einsetzen der Hubsäulen 2. Fixierung mit Klammer 3. Arretierung mit Kick Lock

Flexibility and efficiency often arise from ideas which are compellingly pure and simple. The electrically height adjustable desk OKA EasyUp offers persuasive technology. Partially assembled delivery and tool-free mounting saves transport capacity and allows efficient rearrangement and storage at any time. We also offer EasyUp completely assembled. The rectangular desk EasyUp is available in the dimensions 160/180 cm x 80/90 cm. Set up the desk in three easy steps following the Kick & Click™-principle (see graphic above): 1. Insert lifting column - 2. Fixation with clamp - 3. Latching with Kick Lock









Der EasyUp ist bei einer Tischplattenstärke von 25 mm auch mit abgerundeten Ecken erhältlich. Diese mehr Sicherheit und Schutz vor Stoßverletzungen bietende Variante, ist grundsätzlich bei allen Tischlängen und -breiten möglich und unterstützt das mobile Arbeiten. Durch eine farbig abgesetzte Kante kann das Element noch optisch hervorgehoben werden.

The EasyUp is also available with soft edges for a table top thickness of 25 mm. This version is basically possible for all table lengths and widths and offers more safety as it protects against impact injuries and also supports mobile working. The element can be highlighted with a contrasting edge band.

**Individuell und sicher**  
Individual and safe











# Farben und Materialien Colours and materials

Melamin Uni-Dekor Melamine	Melamin Holz-Dekor Melamine wood laminate	Echtholz Furnier Real wood veneer	Metall (glatt) Metal (smooth)
W3 Perlweiß Perl white	YN Esche Cappuccino Ash cappuccino	G0 Weißer Ahorn White maple	J2 Reinweiß Pure white
A1 Lichtgrau Light grey	A9 Ahorn Maple	I9 Eiche hell Oak light	D0 Alusilber Alusilver
B5 Sandgrau Sand grey	LI Eiche Lindberg Oak Lindberg	H6 Buche Beech	I4 Metallgrau Metal grey
W9 Vulkangrau Vulcan grey	B8 Buche Beech	H1 Birnbaum Pear	E3 Graphit-schwarz Graphite black
I4 Metallgrau Metal grey	I6 Buche gedämpft Beech cushioned	I5 Nussbaum Walnut	
A0 Tief-schwarz Dark black	C2 Kirschbaum Cherry	TM Moor-eiche Bog Oak	
D0 Alusilber Alusilver	WM Kirschbaum Romana Cherry romana	H0 Esche-tiefschwarz Ash deep black	
DV Oliv Oliv	C7 Nussbaum Walnut		
W6 Rubinrot Ruby Red	LD Eiche Mokka Oak Mokka		

Die angegebenen Farben und Formen stellen einen Auszug aus unserem Sortiment dar. Druckbedingte Farbabweichungen und Farbänderungen vorbehalten. Das komplette Sortiment sowie die Maße entnehmen Sie bitte unseren Planungsdaten. Zur Farbauswahl nutzen Sie bitte unsere Farbmuster.

# OKA Easy Up / Technische Details Technical details

			
Beinraumblende Legroom trim panels	Stellgleiter 15 mm Adjustable feet 15 mm	Kabelablage Cable Tray	Kabelkanal Basic Cable channel basic
			
Bedienelement Auf/Ab und LED / Memory Control element Up/Down and LED / Memory	Ausführung mit abgerundeten Ecken Version with soft edges	PC Halter PC bracket	Ausführung teilmontiert, System: Kick & Click™ Type partly assembled, System: Kick & Click™

# Programmübersicht Program overview

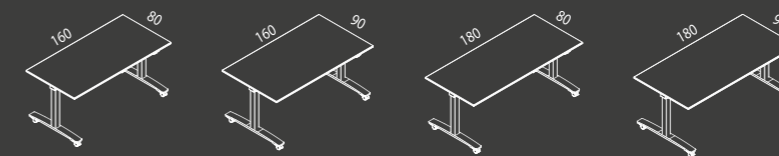

OKA Produkte sind zertifiziert nach:

OKA products have been certified according to:



OKA ist zertifiziert nach:

OKA has been certified according to:



Eine detaillierte Programmübersicht finden Sie hier:  
You can find a detailed program overview here:



The specified colours and shapes provide an extract from our product range. Print-related colour differences may change without notice. The complete range as well as the extent please refer to our planning data. For colour selection, please use our color samples.



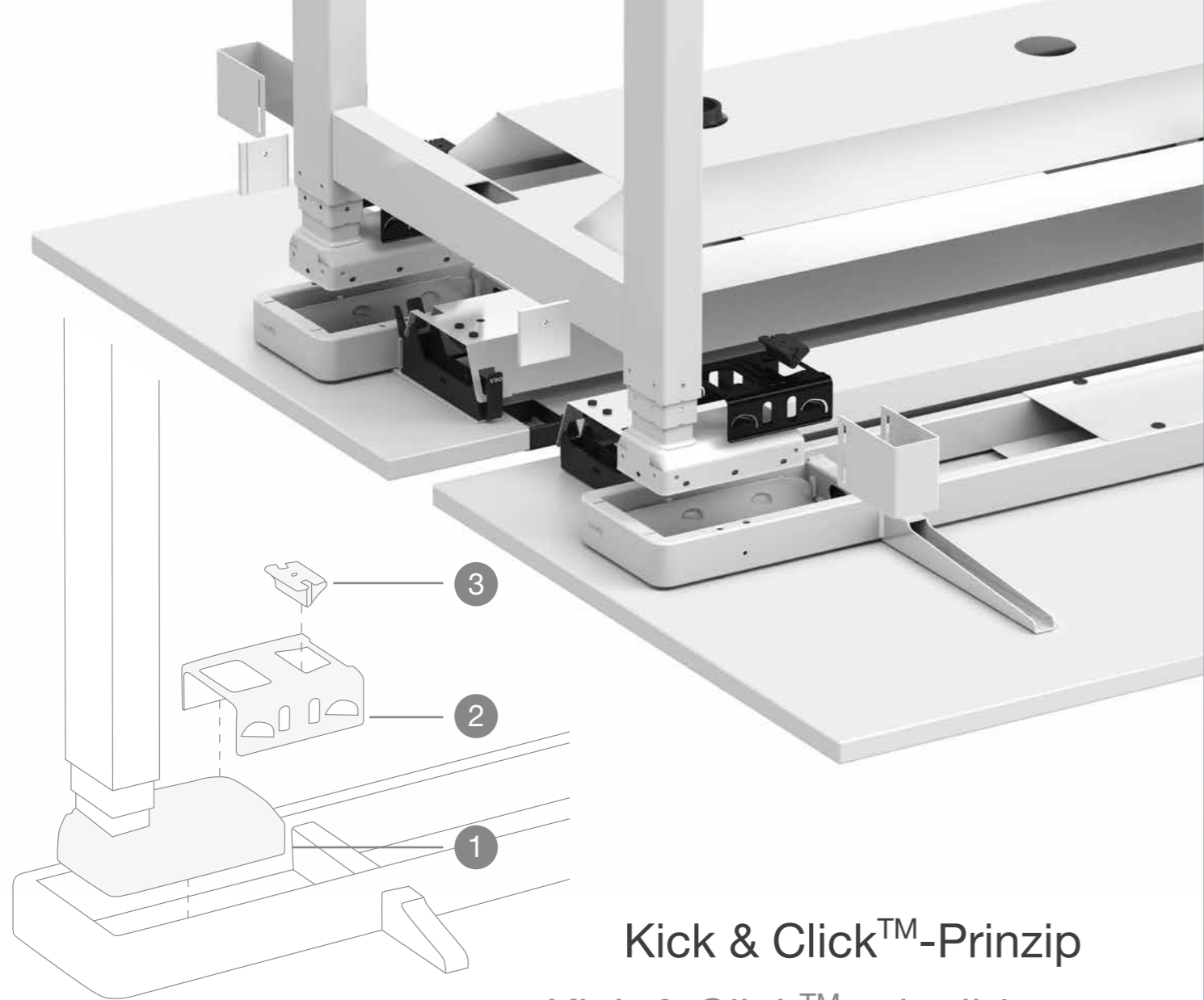

## Kick & Click™-Prinzip

### Kick & Click™ principle

## OKA EasyUp Twin

### OKA EasyUp Twin

In Anbetracht der sich stetig wandelnden Arbeitsbedingungen und damit korrelierenden heutigen Arbeitsplatzkultur, bei der insbesondere Teamarbeit und Networking im Mittelpunkt steht, kreierte OKA eine passende Lösung – den EasyUp Twin. Auf Basis einer gemeinsamen Gestellplattform beeindruckt die 2er-Bench nicht nur durch ihre intuitive Höhenverstellung, die die elektromotorische Höhenanpassung von zwei separaten Arbeitsflächen in einem Verstellbereich von 650–1300 mm ermöglicht, sondern auch mit dem werkzeuglos klickbaren Aufbau nach dem Kick & Click™-Prinzip. Durch das Anbringen von OKA SpaceLine Trennwänden oder OKA DeskTOP Screens können die Arbeitsflächen individuell abgegrenzt werden, ohne dabei den schnellen und offenen Austausch untereinander zu gefährden.

In view of the constantly changing working conditions and thus correlating today's workplace culture, which focuses in particular on teamwork and networking, OKA created a suitable solution – the EasyUp Twin. Based on a common frame platform, the bench not only impresses with its intuitive height adjustment, which enables the electromotive height adjustment of two separate work surfaces in an adjustment range of 650–1300 mm, but also with the tool-free clickable construction based on the Kick & Click™-principle. By attaching OKA SpaceLine partition walls or OKA DeskTOP screens, the work surfaces can be individually delimited without jeopardizing the quick and open exchange among each other.











Neben der flexiblen Kombination mehrerer Doppelarbeitsplatzeinheiten als klassische Bench-Konfigurationen überzeugt EasyUp Twin in gleicher Weise als alleinstehender Doppelarbeitsplatz. Die geometrische H-Form der Seitenrahmen sorgt für eine maximale Beinfreiheit bei optimaler Flächennutzung. Die zentrale Kabelwanne bietet eine bequeme und smarte Kabelführung für die Elektrifizierung.

In addition to the flexible combination of multiple double workstation units as classic bench configurations, EasyUp Twin is equally impressive as a standalone double workstation. The geometric H-shape of the side frames ensures maximum leg-room with optimal use of space. The central cable trough offers convenient and smart cable routing for electrification.

**Platzsparend und effizient**  
Space-saving and efficient





## OKA Easy Up Twin / Technische Details

## Technical details



PC Halter  
PC bracket



Screen Desktop - stoffbespannt  
Screen Desktop - covered with fabric



Screen SpaceLine - stoffbespannt  
Screen SpaceLine - covered with fabric



Säule mit Stellgleitern  
Column with adjustable sliders



Kabelanlage  
Cable Tray



Kabelkanal Basic  
Cable channel basic



Bedienelement Auf/Ab  
Control element Up/Down



Bedienelement LED / Memory /  
Erinnerungsfunktion  
Control element LED / Memory /  
Reminder funktion

OKA Produkte sind zertifiziert nach:  
OKA products have been certified according to:



OKA ist zertifiziert nach:  
OKA has been certified according



Kabelwanne  
Cable trough



Kabelbrücke zur Verkettung  
Cable bridge for linking

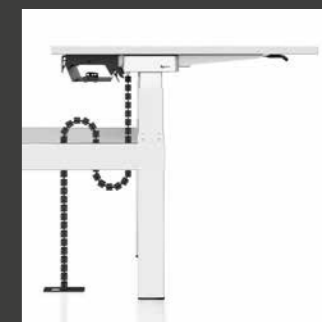









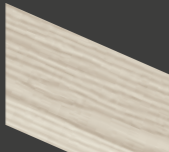

















Vertikale Kabelketten  
Vertical cable bridge

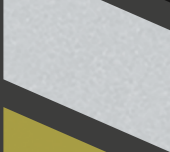

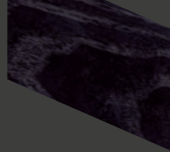
# Farben und Materialien Colours and materials

# Programmübersicht Program overview

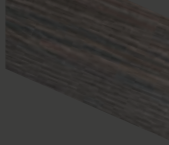
Melamin Uni-Dekor Melamine	Melamin Holz-Dekor Melamine wood laminate	Echtholz Furnier Real wood veneer	Metall (glatt) Metal (smooth)
 W3 Perlweiß Perl white	 YN Esche Cappuccino Ash cappuccino	 G0 Weißer Ahorn White maple	 J2 Reinweiß Pure white
 A1 Lichtgrau Light grey	 A9 Ahorn Maple	 I9 Eiche hell Oak light	 D0 Alusilber Alusilver
 B5 Sandgrau Sand grey	 LI Eiche Lindberg Oak Lindberg	 H6 Buche Beech	 I4 Metallgrau Metal grey
 W9 Vulkan- grau Vulcan grey	 B8 Buche Beech	 H1 Birnbaum Pear	 E3 Graphit- schwarz Graphite black
 I4 Metallgrau Metal grey	 I6 Buche gedämpft Beech cushioned	 I5 Nussbaum Walnut	
 A0 Tief- schwarz Dark black	 C2 Kirschbaum Cherry	 TM Moor- eiche Bog Oak	
 D0 Alusilber Alusilver	 WM Kirsch- baum Romana Cherry romana	 H0 Esche- tiefschwarz Ash deep black	
 DV Oliv Oliv	 C7 Nussbaum Walnut		
 W6 Rubinrot Ruby Red	 LD Eiche Mokka Oak Mokka		

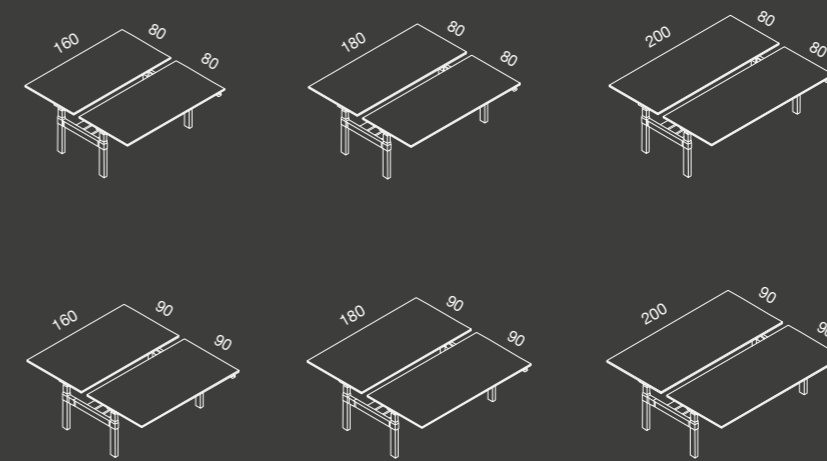

Die angegebenen Farben und Formen stellen einen Auszug aus unserem Sortiment dar. Druckbedingte Farbabweichungen und Farbänderungen vorbehalten. Das komplette Sortiment sowie die Maße entnehmen Sie bitte unseren Planungsdaten. Zur Farbauswahl nutzen Sie bitte unsere Farbmuster.

Eine detaillierte Programmübersicht finden Sie hier:  
You can find a detailed program overview here:

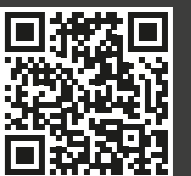

The specified colours and shapes provide an extract from our product range. Print-related colour differences may change without notice. The complete range as well as the extent please refer to our planning data. For colour selection, please use our color samples.





# wir sind ihr büro.

## **OKA Büromöbel GmbH & Co. KG**

Eibauer Straße 1–5, D-02727 Ebersbach-Neugersdorf, Germany

tel 0049.3586.711-0, fax 0049.3586.711-170

[www.oka.de](http://www.oka.de)

Alle Rechte bei OKA Büromöbel GmbH

All rights: OKA Büromöbel GmbH

Gedruckt in Deutschland auf chlorfrei gebleichtem Papier.

Printed in Germany on chlorine-free bleached paper.

